



✧

✧

✧

C

1. I		4
1.1 M		4
1.2 D		
1.3 P	I	5
2. 		5
2.1 G	 G	5
2.2 P	P	7
2.3	  G	7
3. M	I	8
3.1		8
3.2 		8
3.3		9
3.4		10
4.		22
4.1 M		22
4.2 		22
4.3 G		22
4.4 G		26
5. M		28
5.1 A	-	

◇

◇

◇

◇

◇

◇

◇

◇

◇

◇

◇

◇

◇

◇

◇

◇

◇



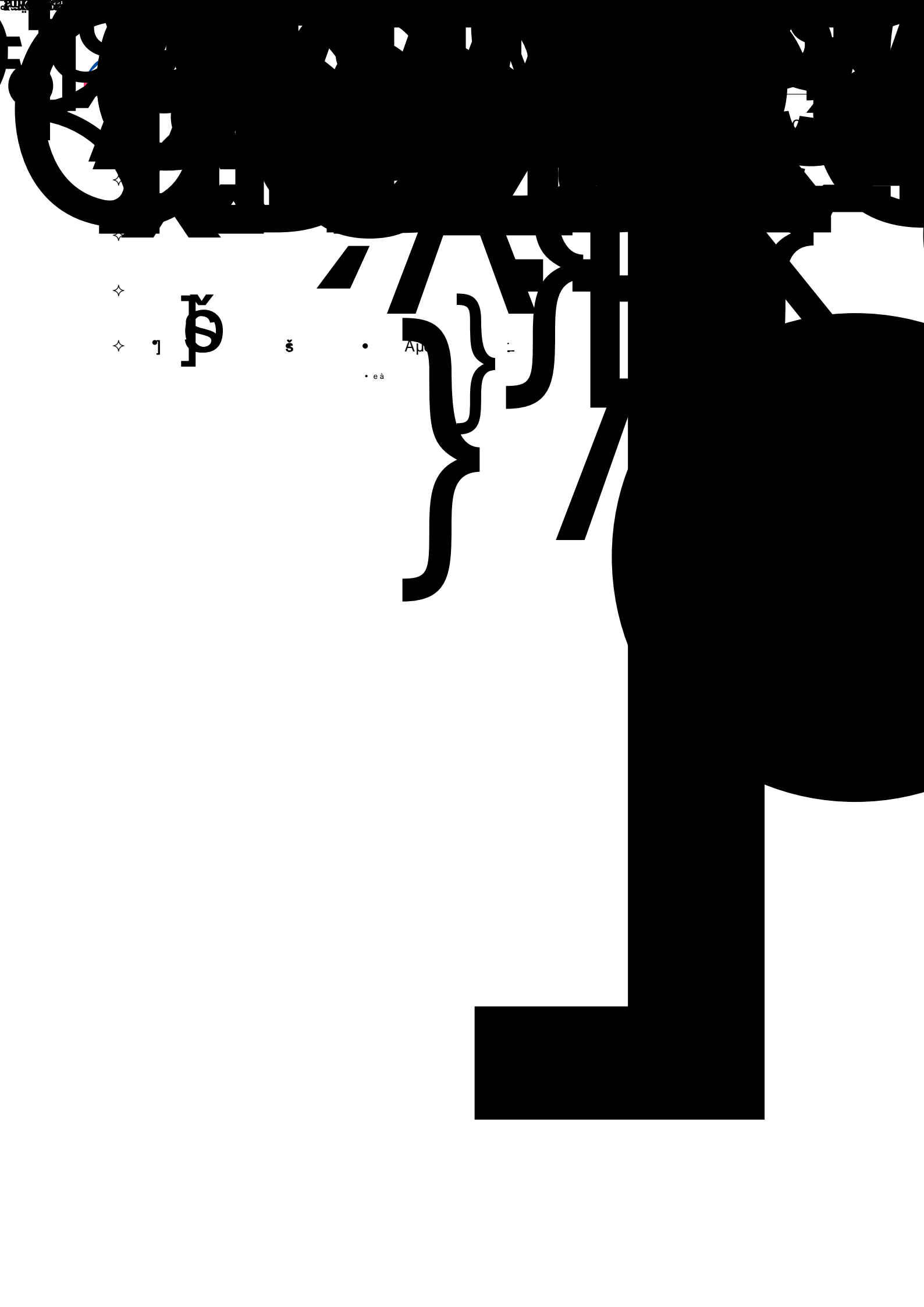

◆

◆

7

§

š

•

Ap

i

• eā

◇

◇

◇

◇

◇

◇

◇

◇

◇

◇

◇



◇

◇

◇

◇

◇

◇

◇

◇

◇

◇

◇

◇

◇

◇

◇

◇

◇

◇

◇

◇

◇

◇

◇

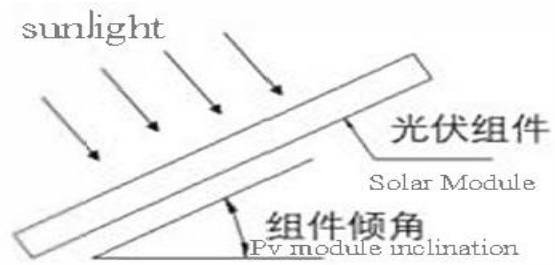
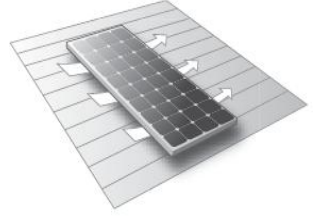

Figure1 Angle of Module installation

◇

◇

◇



◇

◇

◇

◇

◇

◇

◇

◇

◇

◇

◇

◇

◇

◇

◇

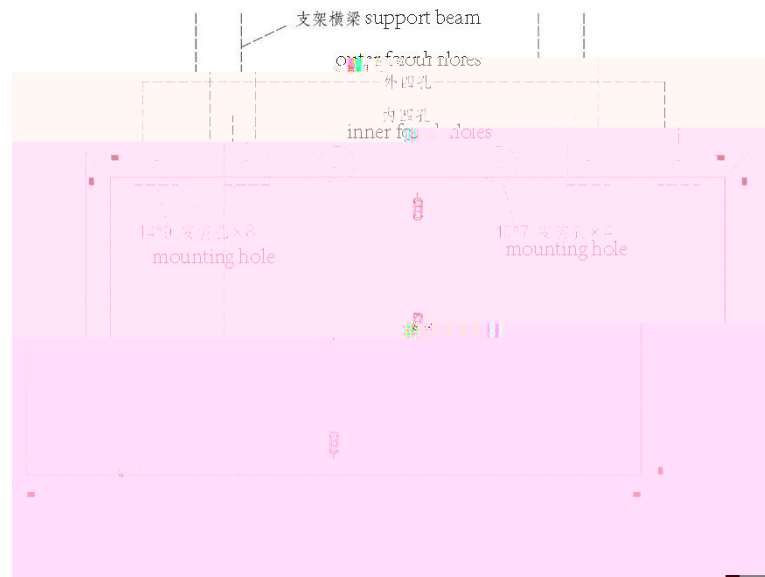
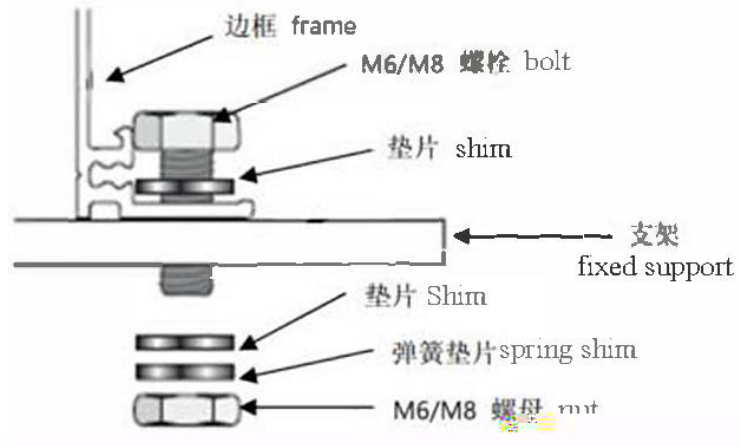

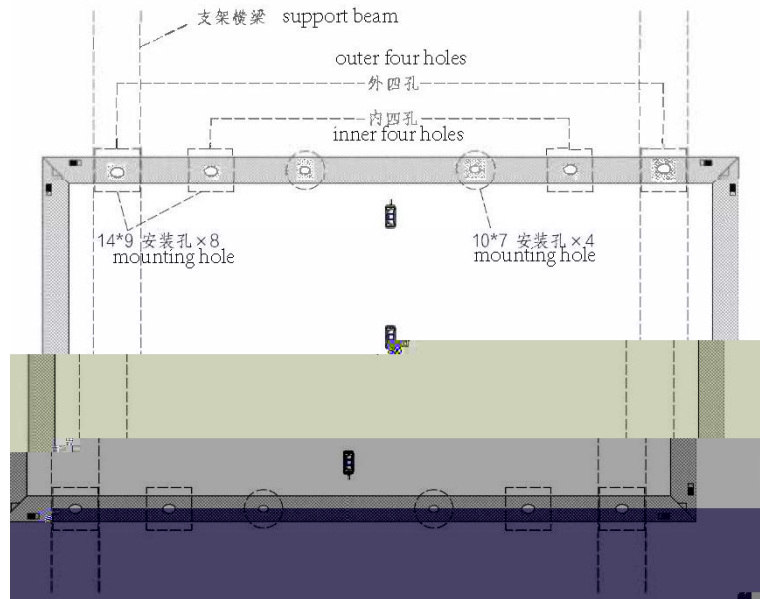

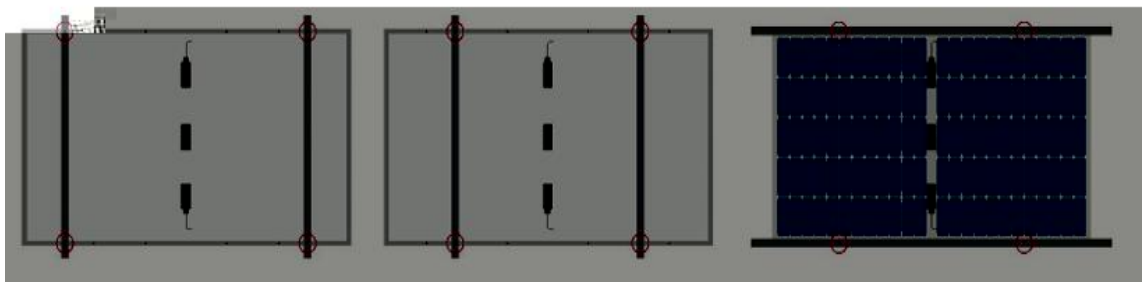



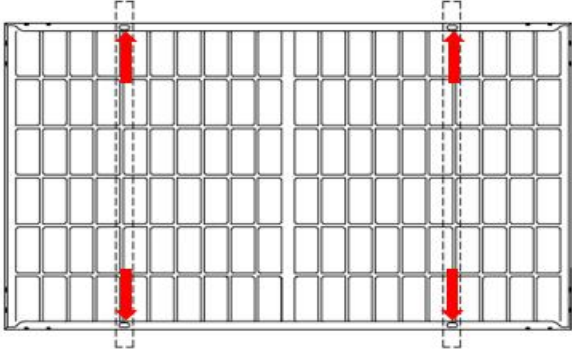
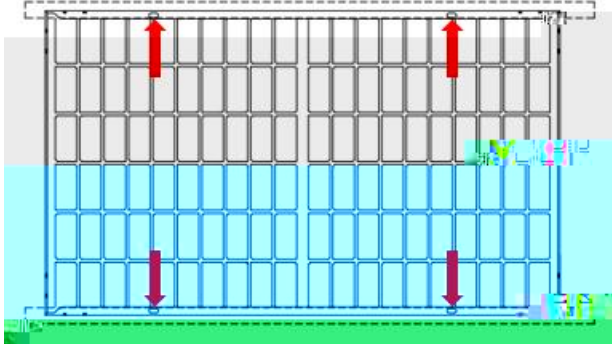

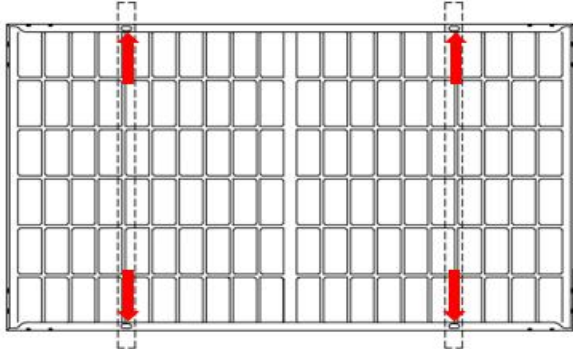
◇

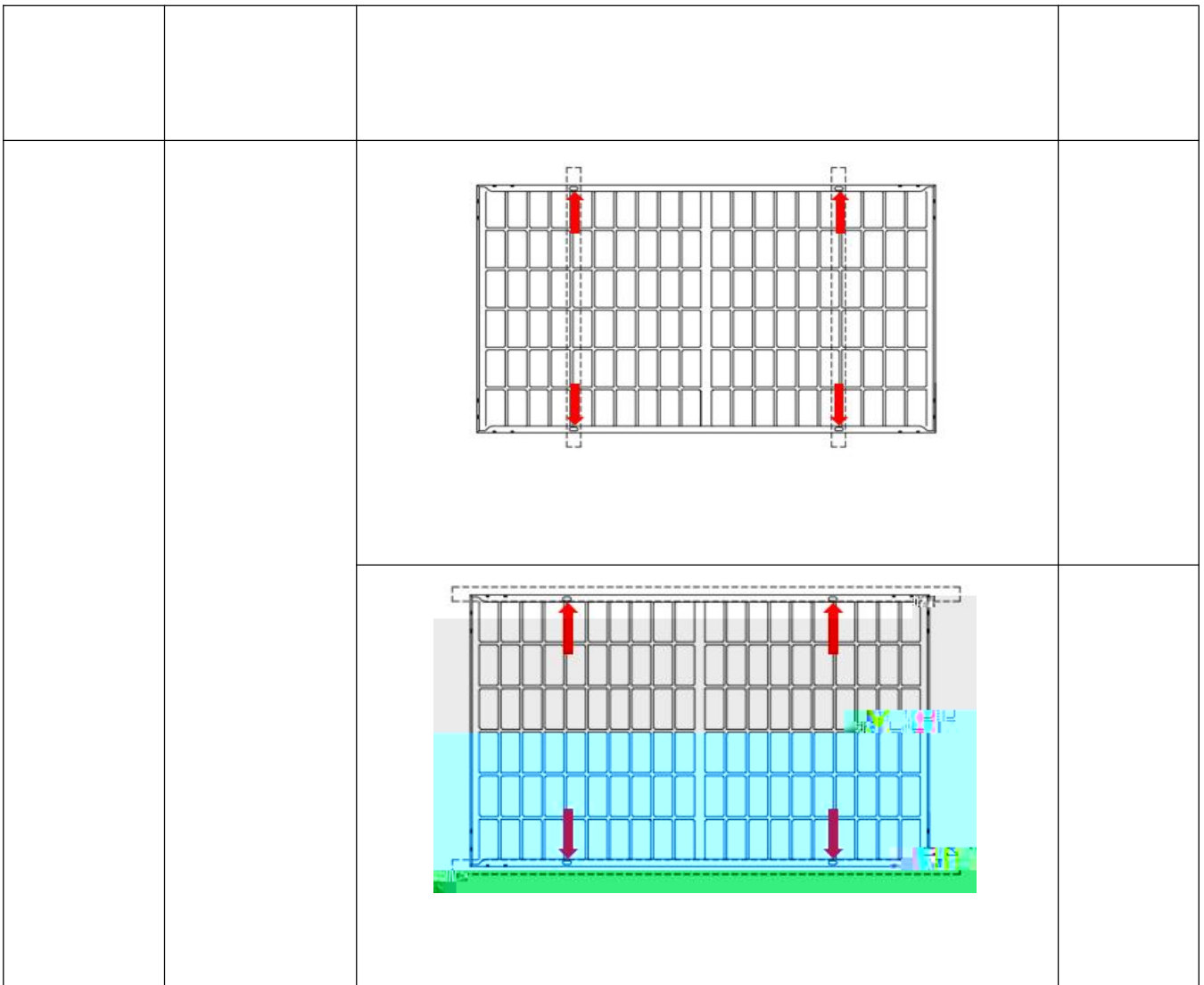
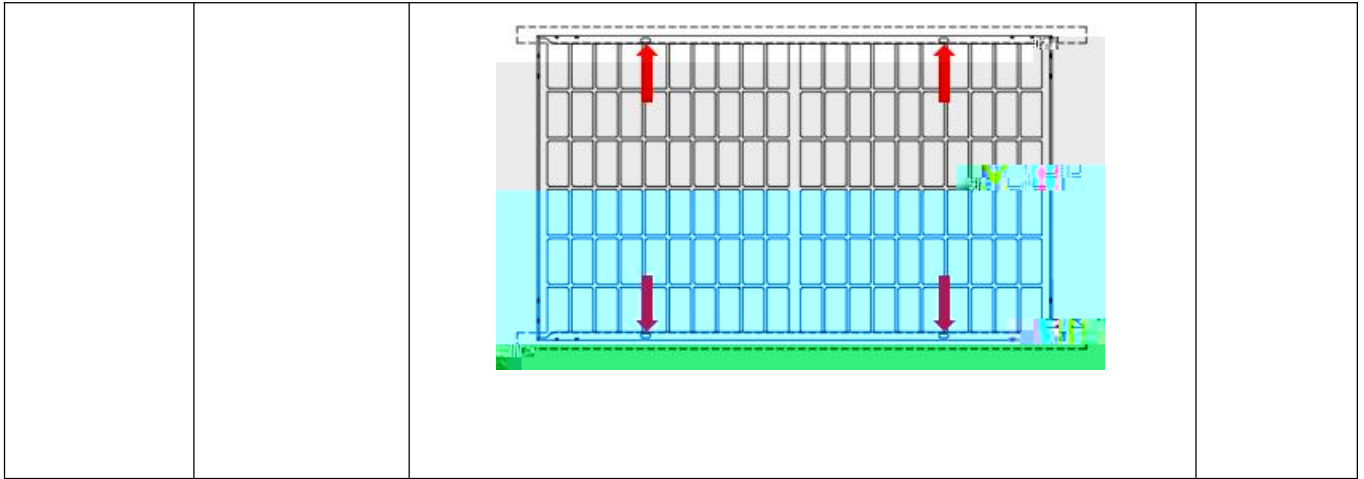
◇

◇

◇

◇

◇

◇

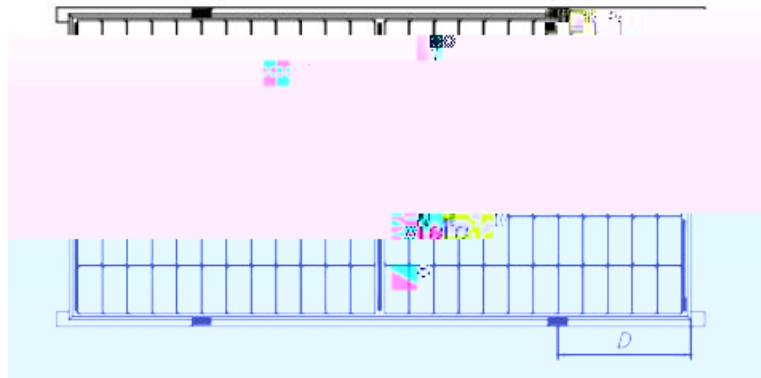

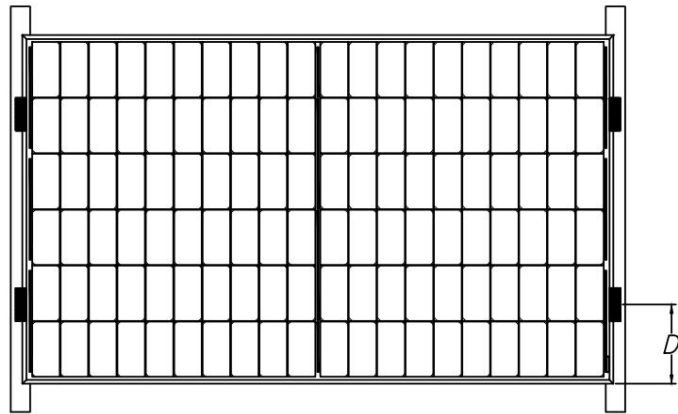
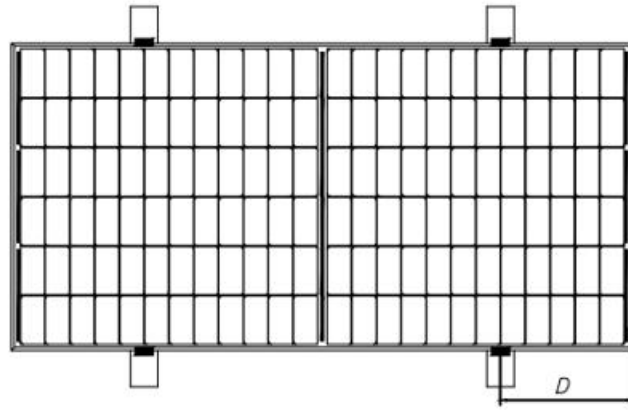

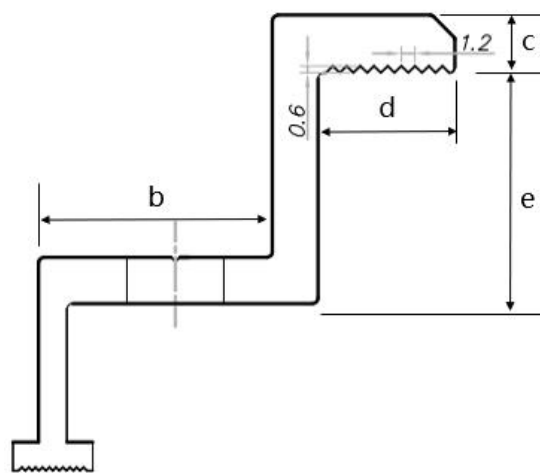
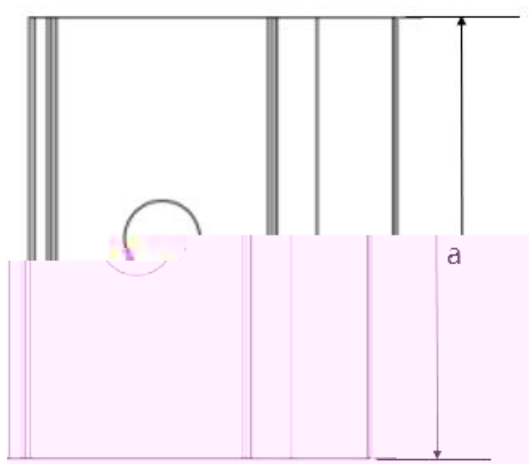

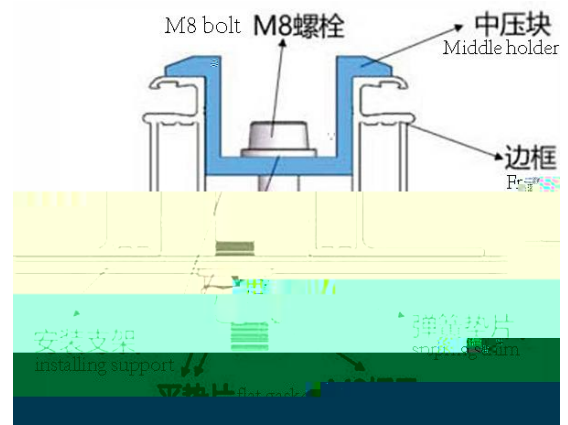
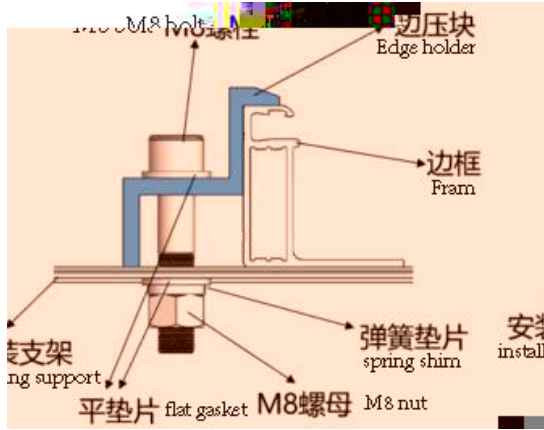

◇

◇

◇

◇

◇

◇



◇

◇

◇

◇

◇

◇

◇

◇

◇

◇

✧

◇

◇

◇

◇

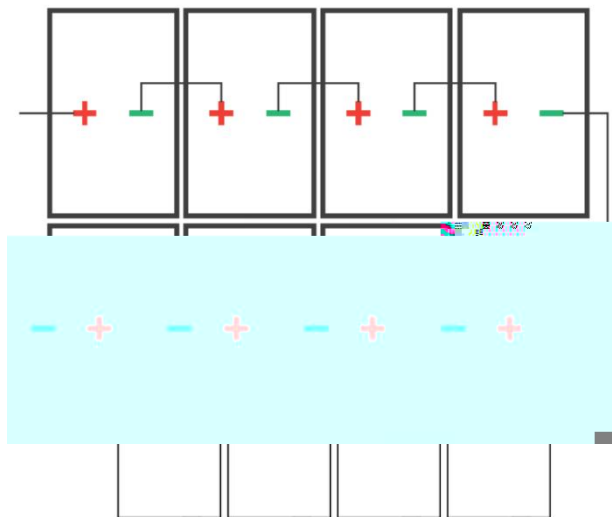

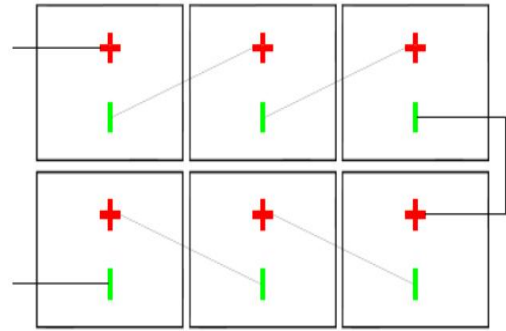

◇

◇

◇

◇

◇

◇

◇

◇

零件 part	schematic diagram	连接方式 link mode
		<p>Place star washers, flat washers, and ground wires in turn, turn, thread screws through the ground holes, and tighten them to secure adjacent components.</p>

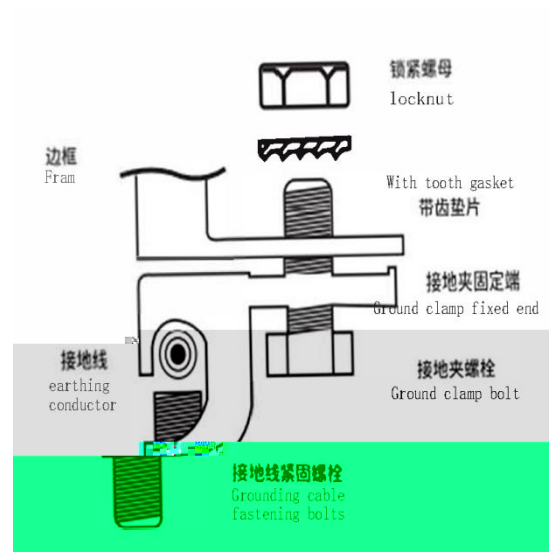

✧

✧

◇

◇

◇

◇

◇

◇

◇

◇

✧

✧

✧